

minicat
ULTRA LIGHT CATAMARAN

THE SAILING BOAT
THAT FITS IN
YOUR CAR.



minicat

310.SUPER

USER'S GUIDE / 2012 EDITION

The first time you read these instructions please do so whilst viewing the accompanying DVD Instructions.

Introduction

This Guide will help you to control your boat easily and safely. It contains a detailed description of the boat and information about its assembly, operation and maintenance. Please, read it carefully, view the accompanying DVD and get fully acquainted with the boat before using it.

This User's Guide is neither a training manual of sailing safety, nor a sailing course. If this is your first boat, to ensure your comfort and safety familiarise yourself with the operation of the boat before sailing it for the first time. Either your MiniCat retailer, the National Sailing Federation, or your local sailing club will be pleased to recommend you to an appropriate sailing course, or qualified sailing instructors. Do not set sail if the expected sailing conditions (wind force, wave height) do not correspond to the design category of your boat. Any changes to your MiniCat which could influence the safety characteristics of the boat, must be performed, verified and documented

by a competent and authorised person. The boat manufacturer cannot bear the responsibility for any unapproved changes. Always keep your MiniCat maintained and take into account any deterioration of its condition, which may occur as a consequence of heavy usage or misuse. Despite its strength, your MiniCat may be seriously damaged if it is not used properly. This will jeopardise your safety when sailing.

Always adjust the speed and the heading of the boat according to the sailing conditions (wind force, wave height).

All persons using any sailing craft must wear life jackets.

Caution !

Please pay special attention to the selection of your life jacket. It must be equipped with a label containing the information about the carrying capacity and reference to the certificate of safety.

Please keep this User's Guide and the accompanying DVD in a safe place and give it to the new owner when selling the boat.

Manufacturer's name and address:	Martin Horák - Design Václava Kulíška 1174 686 05 Uherské Hradiště Czech Republic
Manufacturer's code:	HOC
Name of the model:	MiniCat 310 Super
Design category of the boat:	"D" - Wind max. 4 Beaufort !
Empty weight of the boat:	35 kg (78 lbs)
Maximum permitted load:	235 kg (517 lbs) (see the carrying capacity)
Maximum weight of the loaded boat:	270 kg (595 lbs)
Drive:	By sails
Sails:	Main sail + fore sail
Main sail area:	3.75 sq.m (40.4 sq.ft)
Foresail area:	1.4 sq.m (15.1 sq.ft)
Length of the boat:	3.1 m (10.2 ft)
Width of the boat:	1.4 m (4,6 ft)
Height of the mast:	3.8 m (12.5 ft)
Floats operation pressure:	0.025 MPa (3.6 psi)

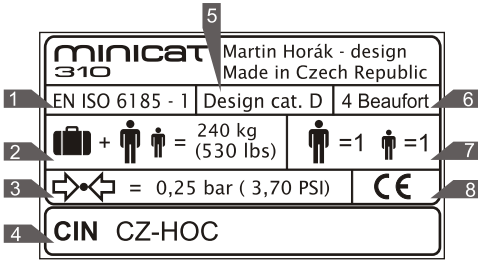

- 1 Norm
- 2 Permitted loading capacity (Persons + luggage)
- 3 Suggested operational pressure
- 4 Serial number
- 5 EU design category
- 6 Max. wind force
- 7 Permitted human capacity
- 8 CE-declaration

Warning !

Maximum wind force

4 Beaufort = 20–28 km/h
 13–17 mph
 11–15 kn
 5.5–7.9 m/s

Maximum number of occupants

1 adult + 1 child - not exceeding 235 kg
 (Total weight 270kg).

Warning !

Do not exceed the determined maximum number of occupants. Regardless of the number of occupants on the boat the total weight of occupants and equipment must not exceed the maximum permitted load. Sit only on the seats.

Carrying capacity

235 kg

The maximum permitted load includes the weight of all persons onboard and any personal items, equipment or baggage.

Warning !

Never exceed the maximum permitted load when loading the boat. Always the boat carefully and allocate the individual weight according to the design of the boat. Avoid the location of heavy objects at the top. Disregarding these instructions may cause the boat to capsize and may result in damage and injury.

Always check your MiniCat before sailing !

Perform a visual check of all parts of the boat before each sailing.

Protection against falling overboard and how to get back on the boat:

Sit only in the places made for sitting. These are the parts of the frame at the rear half of the floats. The stability of the boat will be reduced if you sit anywhere else.

It is necessary to protect the trampoline from damage, especially rupture by sharp objects, or from careless handling.

For ease of access onto the boat from the water, there are fabric handles on both sides of the floats.

Assembly of the boat

- please view the instruction DVD

1. Carefully remove the individual parts from the bag on a flat surface, ideally on a grass area to avoid any damage.

2. Run the lateral aluminum tubes through both parts of the trampoline (fabric board) and insert them into the aluminum parts (see fig. 1).

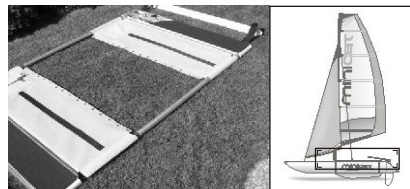

1.



3. Run the rope through both parts of the trampoline (see fig. 2.), tighten it firmly and lock with a knot. This way, the whole frame is tightened.

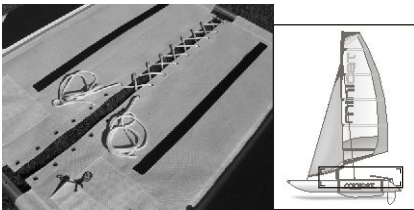

4. Run the unpacked empty floats through the two belts, in the right direction, on both sides of the frame (fig.3).



3.

Before inflation, check the status of the valves. Set the valves to the closed position, slightly push on the centre pin, turn the pin and release the pressure on the pin to enable it to sit in the higher position.

To inflate your MiniCat there use the pump supplied. Inflate the floats partially and align them into position. Then inflate the floats fully to their operating pressure.

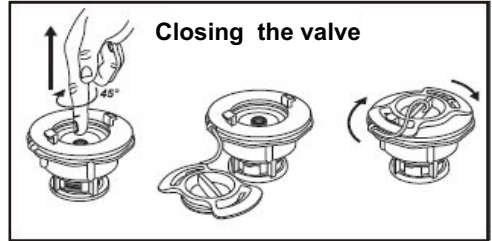
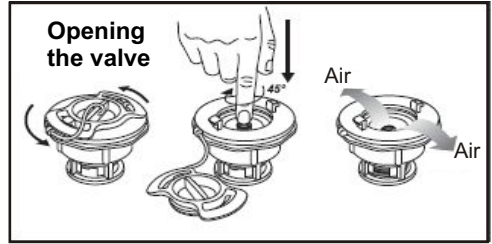

5. Assemble the central tube from tubes No.1 and 2 and attach it, using the washers to the frame so that the shorter tube No.2 will be in the rear part of the frame. Make the connection as shown in fig. 4.

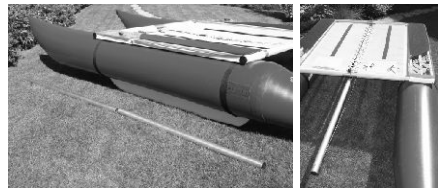

4.

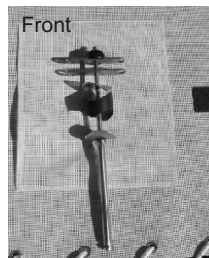

Front



Back

6. Put together the three-part mast the single sections of the mast are simply inserted into each other (fig.5).

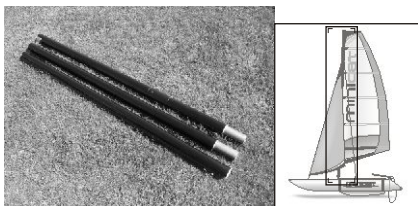

5.

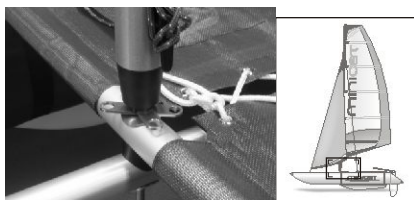

Caution !

Each time your MiniCat is used pay special attention to ensure the ends of the mast sections are free of sand, grit and dirt. Lubricate after each use.

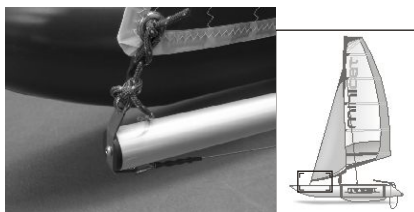

7. Slip the main sail into the groove in the mast. Pull the lift rope of the main mast through the pulley at the top of the mast. In the upper part of the mast (approximately 80 cm from the top), attach the side anchorage ropes of the mast.

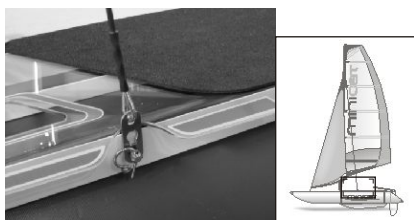

Attach the jib. Erect the mast with the sails attached and ensure its position with the anchorage ropes. Anchor the middle rope to the longitudinal central tube (a) and the two side anchor ropes to the anchor points on the side parts of the frame. By screwing out the central nut under the mast you will tighten and take the strain on all the anchorage ropes.

8. At the rear part of the frame, install on the longitudinal central tube the yoke of the rudder (fig. 6). Attach the rudder using one vertical bolt and nut (with lock), which serves also as the rotation pin.

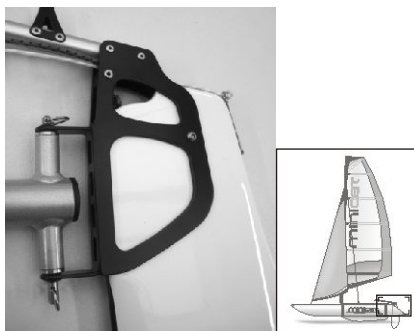
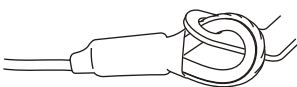

6.

Warning !

- If you experience a loss of pressure of 20% of operating pressure inside a 24 hour period when external temperature is constant it is considered to be normal and no reason for a complaint to the manufacturer or a warranty claim!

- There is a possibility that the flat valve can become a little loose after the first few pumpings, and that can result in a little air escape around the valve (being a result of the stretching and contracting of the boat skin). In case this happens with your boat, it is sufficient to turn the valve with the valve key by about one quarter to one half a turn until the resistance becomes too great.

- Water should never come inside of the tubes. In case this happens please empty as soon as possible and dry throughout. Water inside of the tubes can cause a damage to the inner rubber of the tube and this can cause I-beam damages as well.

- If the boat is standing still on a shore for a longer periods of time, please dismantle the keel fins or use the special stands (see our Spare Parts & Accessories Catalogue) under the floats which will prevent the pressure on the floats. You will avoid a possible damage of the keel fins and floats.

- Maximum operating pressure in the floats (air chambers) is 0.025 MPa (3.6 psi). If there is an increase of the ambient air temperature

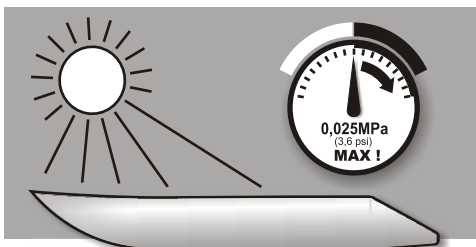

When exposed to the sun, the pressure in floats increases
– let air out gradually!

(due to the heat of the sun) the air pressure inside the floats can increase. The air pressure of the floats should be checked and air released if necessary to avoid eventual damage.

- Before setting sail it is advisable to familiarise yourself with any local regulations or restrictions for the piece of water in which you intend to operate.

- MiniCat is not intended to be towed behind a motorised craft. It must not be towed, slide moved, or otherwise extensively loaded.

- Any sharp objects must be securely packaged.

- Valuable items and personal effects must be placed in a waterproof package and placed in the pockets on the trampoline.

- Bright sunlight will eventually have a deteriorating effect on the rubber surface of the floats, therefore wherever possible when your MiniCat is not in use it is advisable to leave the boat out of direct strong sunlight.

- When sailing on large open water (sea, lake) pay close attention to the wind directly from the coast. It is possible to be blown offshore.

- MiniCat must not be used in bad conditions, for example, low visibility, night, fog, rain.

Instructions for drying, storage, cleaning and maintenance of your MiniCat

After sailing and before storing your MiniCat it is necessary to rinse the boat using water and a mild soap or detergent, and then allow the boat to dry out thoroughly. After sailing it in salt water it is necessary to wash the boat with fresh water. It is recommended to clean all parts from dirt, sand and other impurities using an absorbent cloth. Please note that oil, petrol, acetone, kerosene, paraffin and similar solvents and chemicals disagree with the rubber layer on the surface of the boat and must be avoided.

Before storing your MiniCat and from time to time, we recommend that you clean the boat thoroughly and treat the surface of the rubber floats. The **'MiniCat Maintenance Kit'** includes everything you need for the care of your MiniCat including cleaning and preserving fluid, lubricant and silicone oil.

Carefully pack the dry, deflated floats, cleaned from sand and dust, so that the number of folds will be as few as possible. The folds especially at the edges of the packed float have to be protected to prevent unnecessary wear. Care should also be taken of the cover of the inflation valve, and to avoid any damage to the floats during packaging.

It is recommended after each sailing, to treat the connections of the mast and of the longitudinal central tube using silicone oil.

Pay particular attention when putting single parts into the bag to prevent any damage.

Store the packed boat in a dry space protected from direct sunlight and adverse temperatures (rec: 10 -25 °C). Avoid any load or strain being placed on the boat during storage (putting any heavy objects on top of it, etc.)

Careful treatment and good maintenance can increase the life of your MiniCat.

Righting a capsized boat (Turning Turtle)

In case of overturning the MiniCat follow these instructions:

1. Release the jib and the main sail to the maximum to assure the least possible resistance of the sails when righting the boat. On the MiniCat Super and Sport - wind in the jib.

2. Stand on one float then and pull on the mast line and the handle on the other float. Be careful to prevent damage to the keel fins.

After righting the boat use the handles on both sides of the floats to get back on board.

Repair of your MiniCat

Damage to the MiniCat floats can be easily repaired using the supplied '**MiniCat Repair Kit**'.

Repair procedure:

- Mark the damaged area on the boat and select the patch according to the size of the damage.
- The surface of the patch and of the damaged area must be dry, clean, dust-free and without trace of previous adhesive.
- De-grease both the patch and the damaged area using acetone or petrol.
- Apply a thin layer of adhesive to both surfaces.
- When the adhesive is dry to touch attach the patch to the damaged area and apply pressure.

After minor repairs (punctures), it is possible to re-inflate the boat and to continue sailing after just 60 minutes, with larger repairs it is recommended to wait for 24 hours. With more complicated repairs you are recommended to return your MiniCat to your supplier, to the manufacturer, or to an accredited repair-shop.

Careful treatment and maintenance can increase the service life of your MiniCat.

The manufacturer's warranty period is 24 months from the date of the sale.

All warranty repairs are carried out by a designated, authorised repairer or by the manufacturer:

Martin Horák - design
Václava Kulíška 1174
686 05 Uherské Hradiště
Czech Republic
E-mail: minicat@seznam.cz

Warning !

Sailing can be very dangerous and personally exhausting. Therefore, the user of this product must realise, that not following safety precautions may result in serious injury, or even in death. Therefore when using this product pay close attention to following safety precautions:

- Get well acquainted with the operation of this design of boat.
- Ensure that you have first aid training with certification and have emergency/first aid equipment with you when you sail.
- Always use a quality certified life jacket.
- Before each time you sail check your equipment for functionality and that it does not show any signs of damage.
- Do not overestimate your abilities on the water; take care of yourself.
- Ensure your state of health with a doctor before you go sailing.
- Always observe the manufacturer's recommendations regarding the use of this product.
- Never use this product after taking alcohol, drugs or medication.
- Before using this product read the User's Guide carefully.
- Always pay attention to sea winds and currents.
- The user of this product must be familiar with the basic sailing skills and must be aware of the risks attached to this sport.

Useful knots

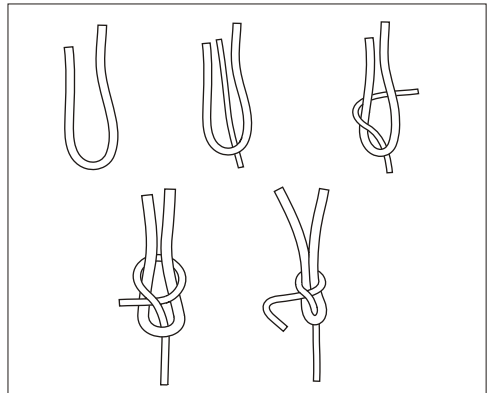
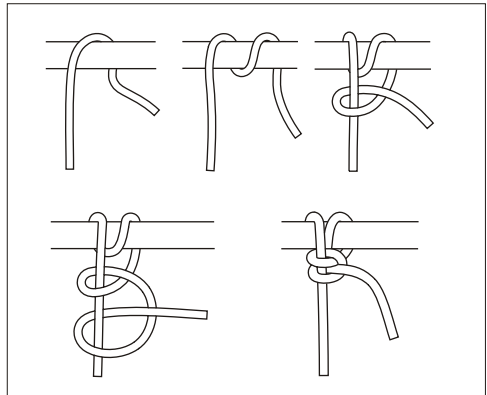
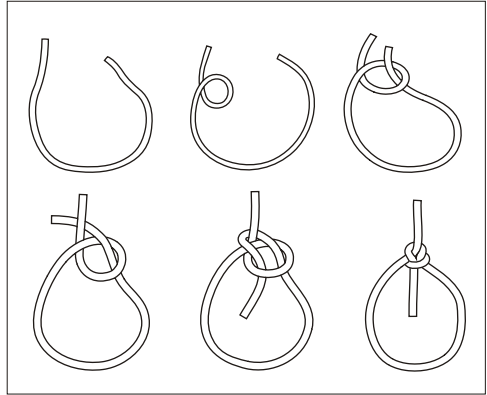

Beaufort scale

Beauf. no.	Description	Wind speed	Wave height	Sea conditions	Land conditions
0	Calm	< 1 km/h < 1 mph < 1 kn < 0.3 m/s	0 m 0 ft	Flat.	Calm. Smoke rises vertically.
1	Light air	1.1–5.5 km/h 1–3 mph 1–2 kn 0.3–1.5 m/s	0–0.2 m 0–1 ft	Ripples without crests.	Smoke drift indicates wind direction, still wind vanes.
2	Light breeze	5.6–11 km/h 4–7 mph 3–6 kn 1.6–3.4 m/s	0.2–0.5 m 1–2 ft	Small wavelets. Crests of glassy appearance, not breaking	Wind felt on exposed skin. Leaves rustle, vanes begin to move.
3	Gentle breeze	12–19 km/h 8–12 mph 7–10 kn 3.4–5.4 m/s	0.5–1 m 2–3.5 ft	Large wavelets. Crests begin to break; scattered whitecaps	Leaves and small twigs constantly moving, light flags extended.
4	Moderate breeze	20–28 km/h 13–17 mph 11–15 kn 5.5–7.9 m/s	1–2 m 3.5–6 ft	Small waves with breaking crests. Fairly frequent whitecaps.	Dust and loose paper raised. Small branches begin to move.
5	Fresh breeze	29–38 km/h 18–24 mph 16–20 kn 8.0–10.7 m/s	2–3 m 6–9 ft	Moderate waves of some length. Many whitecaps. Small amounts of spray	Branches of a moderate size move. Small trees in leaf begin to sway.

Giving Way in Sailing

All types of vessels on the water are governed by the International Regulations for Preventing Collisions at Sea, frequently abbreviated as COLREGS. The entire set of rules is highly complicated, however, when you start sailing, it is sufficient to be familiar with the basic rules that are listed here.

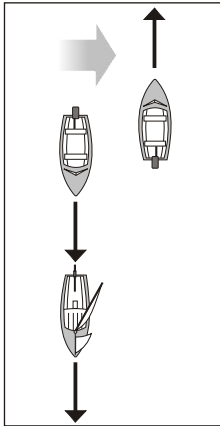

The rules for navigation in a channel (or canal)
All vessels must stay to the right side in channels or canals, so that they meet on their port side.

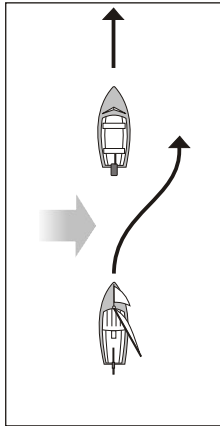

Overtaking rule
An overtaking vessel must keep out of the way of the vessel being overtaken, even in the case of a sailing vessel overtaking a power-driven vessel.

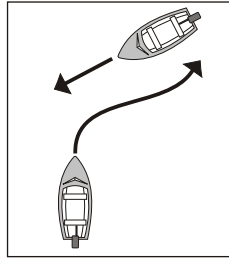

A vessel that arrives from the right is given way in the same way as on the road.

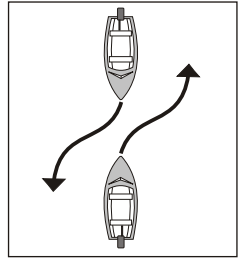

When power-driven vessels meet head-on, they turn their course to the right and meet on their port side.

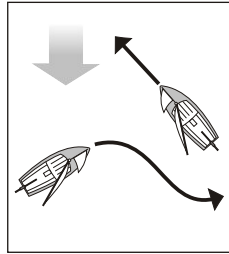

The starboard side vessel alters her course in order to sail behind the stern of the port side vessel.

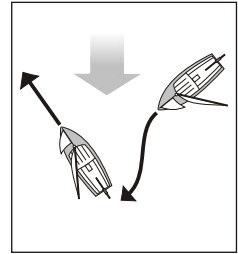

The windward vessel shall avoid the leeward vessel and navigate in order to sail behind her.

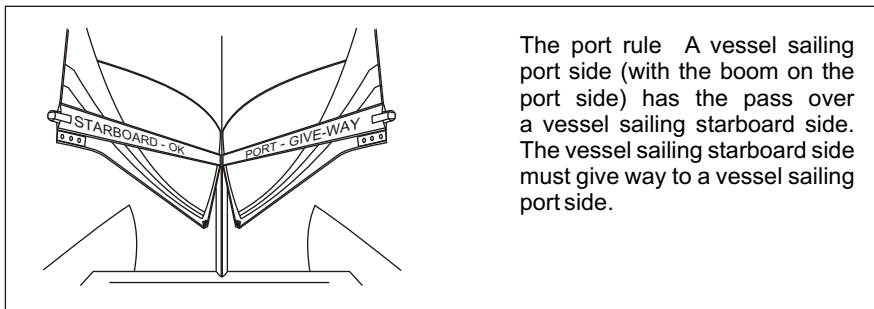

The port rule A vessel sailing port side (with the boom on the port side) has the pass over a vessel sailing starboard side. The vessel sailing starboard side must give way to a vessel sailing port side.



Certificate of Conformity

No. 01 - 09 - 2006

Manufacturer:

Martin Horák - design

Václava Kuliška 1174

686 05 Uherské Hradiště

Company Registration Number: 66787441

Registered MIC (Manufacturer's Identity Code)
according to ČSN EN ISO 10087, Art. 42 - "HOC"

declares and certifies on its exclusive responsibility that the product:

Recreational Craft - MINICAT 310

determined for sailing in protected offshore waters, large lakes, river mouths, bays, etc., is designed and produced in conformity with the requirements of **ČSN EN ISO 6185**, issued by the European Committee for Standardization (CEN) on 10 November 2001 and is safe under the conditions of the above - stated use.

The manufacturer declares that all the products put on the market conform to the technical documentation and to the basic requirements.

Conformity assessment has been conducted according to:

ČSN EN ISO 6185

ČSN EN ISO 10240

ČSN EN ISO 14945

ČSN EN ISO 10087

Directive 94/25/ES

The product meets all the requested values and parameters and all the required tests have been successfully carried out.

In Uherské Hradiště on 13. 9. 2006

Martin Horák
Václava Kuliška 1174
686 05 Uherské Hradiště
IČO: 66787441, DIČ: CZ 7409023309